

INSTRUCTION MANUAL
Lithium Series
Slim 48V 5.1kWh

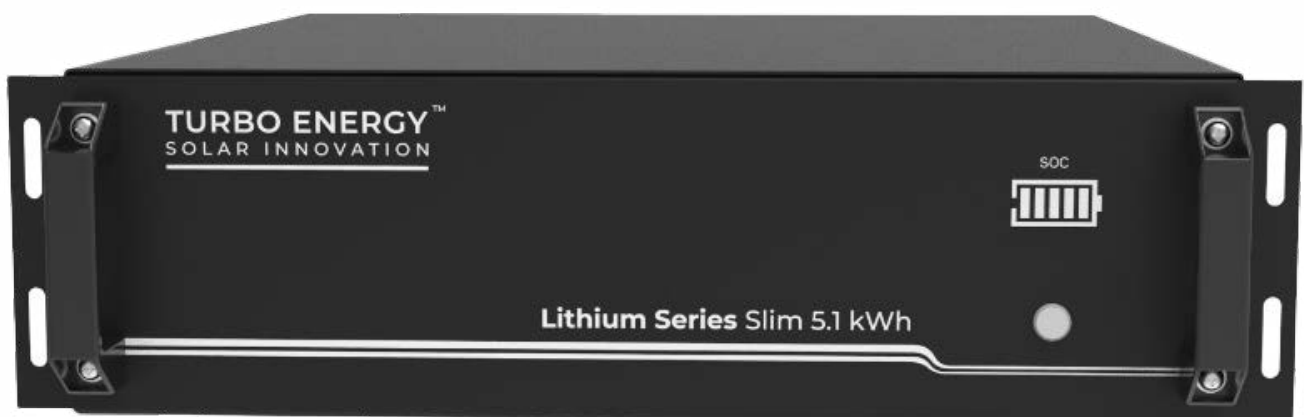

 LONG-LASTING LITHIUM-ION BATTERIES

 MAXIMUM CUSTOMER SATISFACTION

 PLUG & PLAY

10
YEARS
WARRANTY

LITHIUM SERIES SLIM 48V 5,1KWH BATTERY



Read this manual before installing the battery and follow the instructions carefully during the installation process.

Content

1. Scope	3
2. Specifications	3
3. Battery Dimensions.....	4
4. Features	4
5. Operation	4
5.1. Battery front	4
5.2. Battery Back	5
5.3. Assembly and connection	6
5.3.1. Configuration without communications.....	7
5.3.2. Configuration with communications	8
5.4. On and off	9
5.5. LED display	10
5.6. Protection codes	10
5.7. error codes	11
6. Appendix	11
6.1. Instrucciones de seguridad	11
6.2. Safety warnings.....	12
6.3. Warranty	12
6.4. Shipping.....	12
6.5. Storage.....	12
6.6. Contact details.....	12

1. Scope

This document describes the basic operation of the Turbo Energy brand lithium-ion rechargeable battery (**Lithium Series 48V 5.1 kWh Slim model**). This manual contains all the necessary details for understanding the operation of the equipment and for its correct application.

2. Specifications

Electrical	
Nominal Capacity	5.12 kWh
Usable Capacity	5 kWh
Depth of Discharge (DoD)	90%
Nominal Voltage	51.2V
Voltage operating range	43.2 - 57.6V
Cycle Life	>= 6000
Physical	
Weight	44 kg
Dimensions	440 x 460 x 133 mm
Protection class	IP20
Battery type	LiFePO ₄
Operation	
Maximum charge/discharge current	100A (1 C)
Standard charge/discharge current	50 A (0.5C)
Temperature operating range	0°C...50°C
Humidity	20% - 90%
Maximum operating altitude	< 4000 m
BMS	
Self-current consumption (OFF mode)	<100 μ A
Monitoring parameters	System voltage and current, cell voltage and temperature
Communication	Compatible CAN and RS-485

3. Battery Dimensions

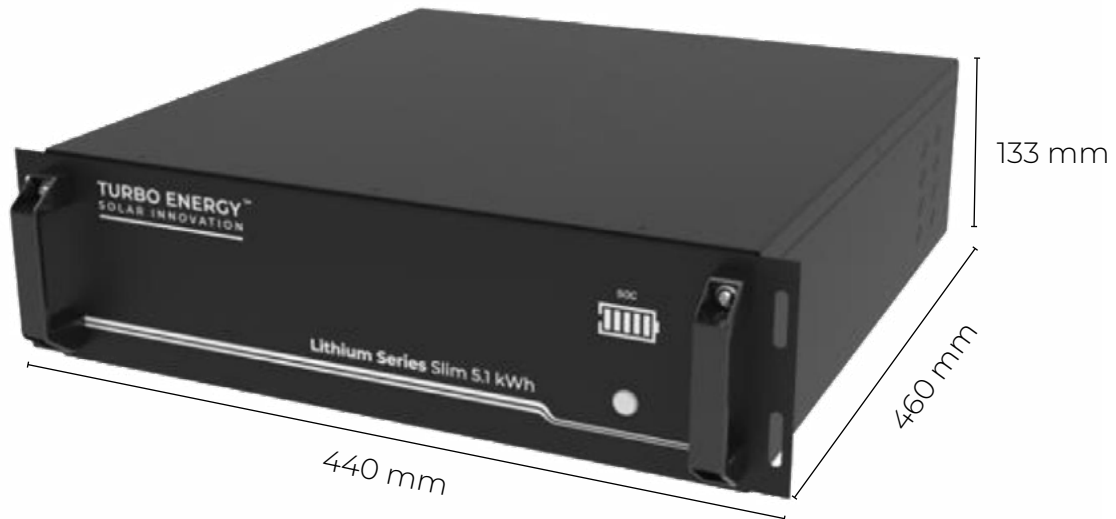

4. Features

The **Lithium Series 48V 5.1 kWh Slim** battery has the following features:

- Designed for use in photovoltaic applications.
- Battery Management System (BMS): The BMS system built into the battery that monitors its operation and does not allow it to work outside the bounds of the design regime (V, I).
- Expandability: The system's accumulation capacity can be expanded by incorporating more batteries.

5. Operation

5.1. BATTERY FRONT



5.2. BATTERY BACK

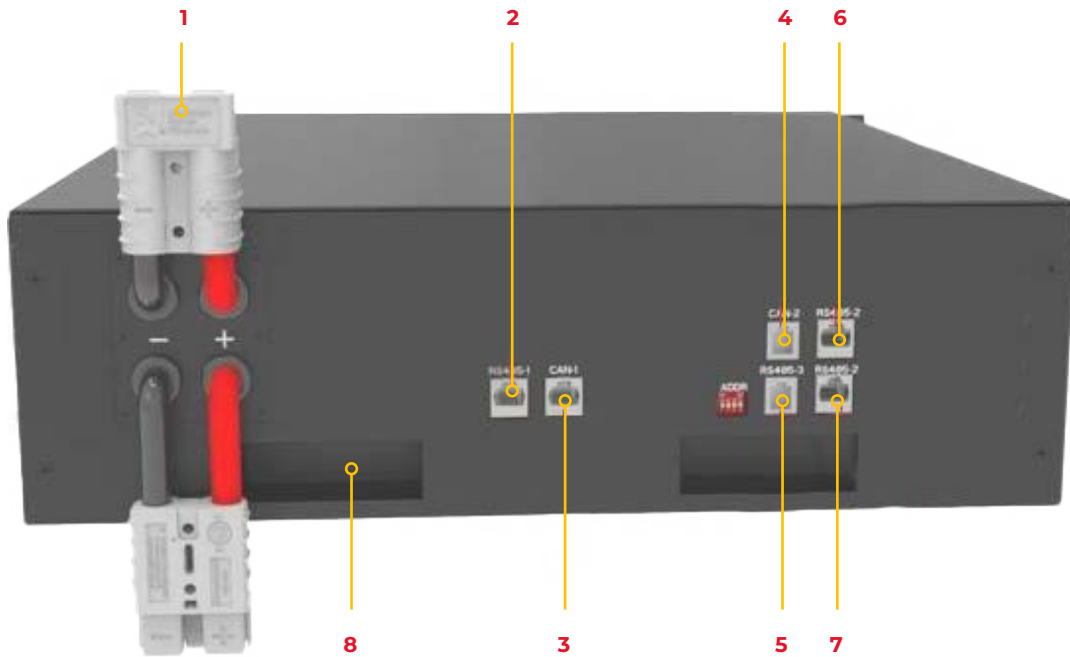

Artículo	Definición
1	Positive and negative connector * 2 - for battery parallel connection and power output, model: Anderson 120A.
2	RS485-1 support the BMS monitor or customer's EMS device.
3	CAN-1 support Turbo Energy™, Goodwe, Solis, Sermatec, Sofar, Ingeteam Inverter.
4	CAN-2 support Victron inverter.
5	RS485-3 support Growatt inverter.
6	RS485-2 support Voltronic inverter and inner parallel communication between batteries.
7	RS485-2 support Voltronic inverter and inner parallel communication between batteries.
8	Handles

The standard packing list of Lithium Series Slim is as follows:

Item	Part name	Description	Quantity
1	Batery	Lithium Series Slim	1
2	RJ45 netting cable	RS485 parallel netting cable / 0.2m	1
3		CANBUS communication cable with Turbo Energy™ inverter / 2m	1
4		CANBUS communication cable with Victron inverter / 2m	1
5		RS485 communication cable with Voltronic inverter / 2m	1
6	Grounding wire	Black / 1.5m / 10AWG	1

5.3. ASSEMBLY AND CONNECTION

Batteries may be connected in parallel up to a maximum of 15. All batteries must be grounded. It is suggested to connect the installation ground to the rack at the same point as all battery lands.

Connection between batteries:

- Up to 15 batteries are allowed to be used in parallel.
- The batteries used in parallel must be the same batch of cases with the same SOC.
- The Voltage difference of batteries used in parallel must be within 0,5V.
- The dimensions of parallel cable must be the same.
- The batteries must be connected two by two with the same cable to the bus, following next scheme.

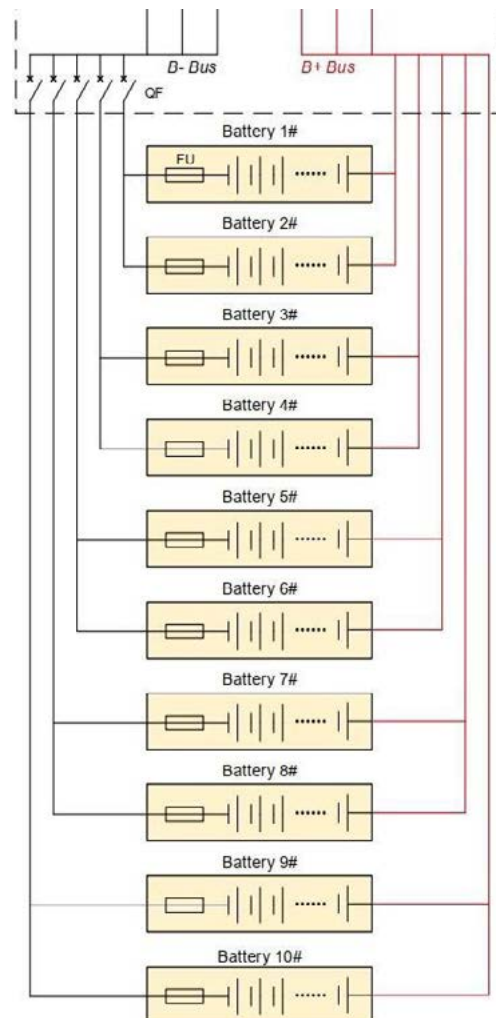

Connection between battery and inverter:

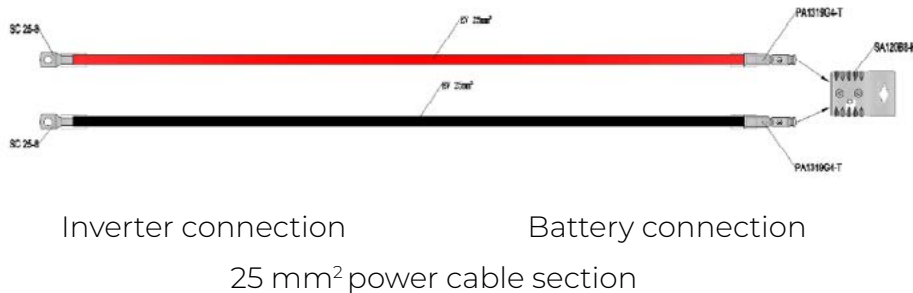

NOTE: Each power cord can carry a maximum of 120 A, so every two batteries would need to connect a new cable to the inverter. However, if the inverter is 5 kW only with one cable it would be enough to be at the limit of the maximum current recommended.



Warning when doing a battery expansion:

It is very important that in the case of connecting batteries in parallel that are not new (for example, we add a new battery to an existing system), we previously perform a voltage balancing (without load) between them to avoid overcurrents that could damage the system. As an alternative to balancing voltages, balancing can be done by equalizing the SOC of the batteries. In addition, when connecting new batteries, we must take into account that the number of batteries at the time of connection must be similar to the number of batteries that are already connected in the system. For example, if we have five batteries installed and we want to connect a new one, we must first connect the new battery with two of the five that were already in place to balance them, and then connect these three with the other three remaining batteries in the system. Batteries should always be connected in groups of similar numbers so that a large group cannot damage a smaller group of batteries at the time of connection.

5.3.1. CONFIGURATION WITHOUT COMMUNICATIONS

For those cases where the battery is intended to operate connected to an inverter without communications, it's not necessary to select a specific configuration of the DIP switches and the batteries do not need to be connected each other with the communication cable.

5.3.2. CONFIGURATION WITH COMMUNICATIONS

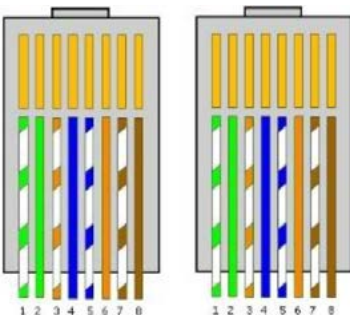
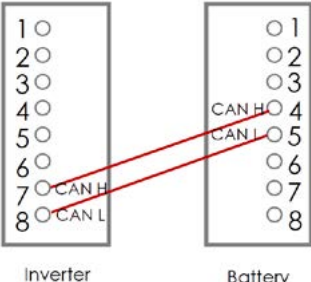
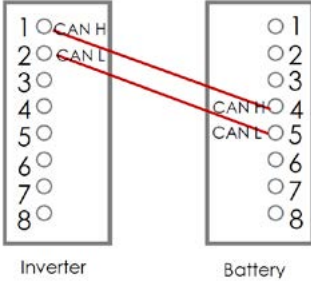
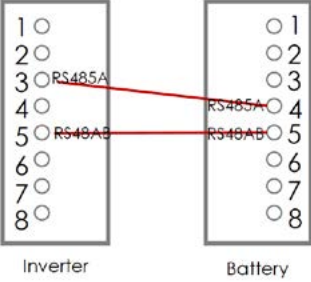

Communication cable:

It will be configured one way or another depending on the inverter used.

<p>Cable configuration Hybrid Inverter Turbo Energy™/Goodwe/ Solis /Growatt</p> <ul style="list-style-type: none"> • It can be used a Straight-through cable • Connect the cable to the CAN-2 port • Growatt inverter is connected to the RS485-3 port 	
<p>Connect the cable to the CAN-2 port</p>	<p>Cable configuration Victron</p> 
<p>Connect the cable to the CAN-1 port</p>	<p>Cable configuration Sofar</p> 
<p>Connect the cable to the RS485-2 port</p>	<p>Cable configuration Voltronic</p> 

DIP switch

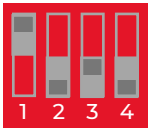
Each module has 4 DIP switches (Dual Inline Package) that will be configured differently according to the number of batteries will be connected.

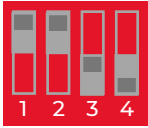
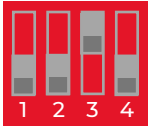
Address	Dial switch position	Explain
1	 <p>1=ON 0=OFF</p>	Pack 1 / Master
2	 <p>1=ON 0=OFF</p>	Pack 2
3	 <p>1=ON 0=OFF</p>	Pack 3
4	 <p>1=ON 0=OFF</p>	Pack 4
...		

5.4. ON AND OFF

To turn on, press the power button for 2 seconds. The BMS will start and the LCD screen light up.

To turn off the batteries, press the power button for more than 3-6 seconds.

Sleep Function

When RS485/CAN communication interruption, no charge and discharge, no button operation, 5 minutes later, the system will go into sleep mode to reduce self-consumption. In this mode, the battery power connectors still have normal battery voltage.

When the battery is in the sleep mode and meets any of following conditions, the system will quit sleep mode and wake up.

1. Charge or discharge current is detected.
2. Press the "ON/OFF" button for 1 second.
3. Access communication cable (RS485/CAN).

Power down function

When any of the following conditions are satisfied, the system will go into power down mode to reduce self-consumption and protect the cells:

1. Press the "ON/OFF" button for 3~6 seconds and release it;
2. The lowest cell voltage is lower than the power down voltage, and the duration reaches the power down delay time (while no charging current).







In this mode, the battery power connectors don't have voltage.

When the battery is in the power down mode and meets any of following conditions, the battery will quit power down mode and wake up.

- Charging current is detected (charging voltage should be higher than 51.2V);
- Press the “ON/OFF” button for 2 seconds and release it.

5.5. LED DISPLAY









The LED light on the front of the battery will indicate the State Of Charge (SOC) as shown in the following table:

SOC LED	Charge status
	SOC < 5%
	5% ≤ SOC ≤ 25%
	25% ≤ SOC ≤ 55%
	50% ≤ SOC ≤ 75%
	75% ≤ SOC ≤ 95%
	SOC ≥ 95%

5.6. PROTECTION CODES

LED Alarm:









Red light: 1 flicker	Green light: N° flickers = protection code
----------------------	--

Protection code	Display LED	Description
1		Temperature difference
3		High temperature
4		Low discharge temperature
5		Charge over-current
6		Discharge over-current
8		Cell overvoltage
9		Cell under voltage
11		Low charge temperature

5.7. ERROR CODES

LED Alarm:

Red light: 2 flickers	Green light: N° flickers = error code
-----------------------	---------------------------------------

Error code	Display LED	Description	Solution
Error 01		Hardware error	Wait for automated recovery. If the problem is not resolved, call for repair
Error 03		Hardware error	
Error 05		Hardware error	
Error 06		Open breaker	Close the circuit breaker after turning off the battery system
Error 07		DIP difference	Maintain consistency of DIP switches, reboot system
Error 08		LMU disconnected (slave)	Reconnect the communication cable
Error 09		SN missing	Enter the serial number, restart the system or call for repair
Error 10		LMU disconnected (master)	Reconnect the communication cable
Error 11		Software version inconsistent	Call for repair

If the battery constantly runs for 30 days and its **SOC has not been corrected**, the discharge function will not be available until the battery is fully charged at least once and the SOC is corrected.

6. Appendix

6.1. INSTRUCCIONES DE SEGURIDAD

1. Please read the battery instructions before use.
2. Keep the battery away from high voltage and out of reach of children.
3. In operation, the battery should be kept in the set temperature ranges (between -10 C and 50 C) and a humidity less than 80%.
4. During handling, be very careful to avoid bumps/falls of the battery.
5. Be careful not to touch the contacts at the same time.
6. The battery, at the end of its useful life, requires a recovery process, not disassemble it.
7. Avoid locating batteries in damp places to avoid danger.
8. When not in use for a long time, store the battery intact and let the battery be half charged. Wrap the battery with non-conductive material to avoid direct contact of the metal. Store the battery in a cool, dry place.
9. Never expose the battery to fire or water.

6.2. SAFETY WARNINGS

1. Do not disassemble the batteries. The inside of the battery has a protective mechanism and a protective circuit to avoid danger. Improper disassembly will damage the protection function permanently, leaving the battery without safety conditions.
2. Never short-circuit the poles of the Battery. Avoid contact of positive and negative poles with metals.
3. Keep the batteries away from fire and extreme temperatures. Monitor the distance to thermal bulbs, stoves, etc.
4. Keep the battery away from the water. Always be careful that the battery is not located in damp places where the dew point can be reached.
5. Do not use batteries that have physical damage that may be due to falls or bumps.
6. Do not weld near the battery.
7. Overheating will result in the loss of the protective function of its life cycle, even, it could render the battery useless and in extreme cases self-ignition of the battery occurs.
8. Never connect this battery in series and connect it in parallel only with identical batteries up to a maximum number of 6.
9. If the battery has liquid leakage, avoid contact with it completely. It can be harmful to the skin, and if you touch the eyes, wash, and go to the hospital immediately for treatment.

6.3. WARRANTY

Please refer to the **Warranty Document** for specific warranty terms.

6.4. SHIPPING

During transportation, keep the battery from acutely vibration, impacting, solarization, drenching.

6.5. STORAGE

Storage environment requirement:

- 1 month: Under temperature of -20°C~ 45°C and relative humidity of 45~85%.
- 3 months: Under temperature of -20°C~ 35°C and relative humidity of 45~85%.
- 6 months and more: Under temperature of -20°C~ 25°C and relative humidity of 45~85%.

The battery must be charged every six months, and must be charged and discharged a complete cycle every nine months.

6.6. CONTACT DETAILS

For any incident with the battery write, indicating your contact details, an email to the address: info@turbo-e.com and we will contact you as soon as possible.

TURBO ENERGYTM
SOLAR INNOVATION

www.turbo-e.com