

Instruction manual

# Lithium Series Slim 48V 2.4 kWh



Read this manual before installing the battery and follow the instructions carefully during the installation process.

## **Content**

1. Scope.....	3
2. Specifications.....	3
3. Battery Dimensions.....	4
4. Features.....	4
5. Operation.....	5
5.1. Battery front.....	5
5.2. Battery pack .....	5
5.3. Assembly and connection .....	6
5.3.1. Configuration without communications.....	8
5.3.2. Configuration with communications.....	8
5.4. On and Off.....	11
5.5. LED display.....	11
5.6. Protection codes.....	12
5.7. Error codes.....	12
6. Appendix.....	13
6.1. Security instructions.....	13
6.2. Safety warnings.....	14
6.3. Contact details .....	14

## 1. Scope

This document describes the basic operation of the Turbo Energy brand lithium-ion rechargeable battery (Lithium Series Slim 48V 2.4 kWh model). This manual contains all the necessary details for understanding the operation of the equipment and for its correct application.

## 2. Specifications

### Electrical

Nominal Capacity	2.4 kWh
Max. Output power	2.2 kWh
Depth of Discharge (DoD)	90%
Nominal Voltage	48 V
Voltage operating range	40.5 – 54V
Cycle Life	>= 6000

### Physical

Weight	23 kg
Dimensions	440 x 505 x 66.5 mm
Protection class	IP20
Battery type	LiFePO4

### Operation

Maximum charge/discharge current	50A (1 C)
Standard charge/discharge current	25 A (0.5C)
Temperature operating range	0°C...50°C
Humidity	20% - 90%
Maximum operating altitude	< 4000 m

### BMS

Power consumption (Off mode)	<100 μ A
Monitoring parameters	System voltage and current, Cell voltage and temperature
Communication	Compatible CAN and RS-485

### Compatibility

Inverters	Turbo, Victron, Voltronic, Goodwe, Growat, Solis, Sofar, Sermatec, SMA, Ingeteam, Darfon.
Max parallel units	15

### 3. Battery Dimensions



### 4. Features

The **Lithium Series Slim 48V 2.4 kWh** battery has the following features:

- Designed for use in photovoltaic applications.
- Battery Management System (BMS): The BMS system built into the battery that monitors its operation and does not allow it to work outside the bounds of the design regime (V, I).
- Expandability: The system's accumulation capacity can be expanded by incorporating more batteries.

## 5. Operation

### 5.1. Battery front



### 5.2. Battery pack

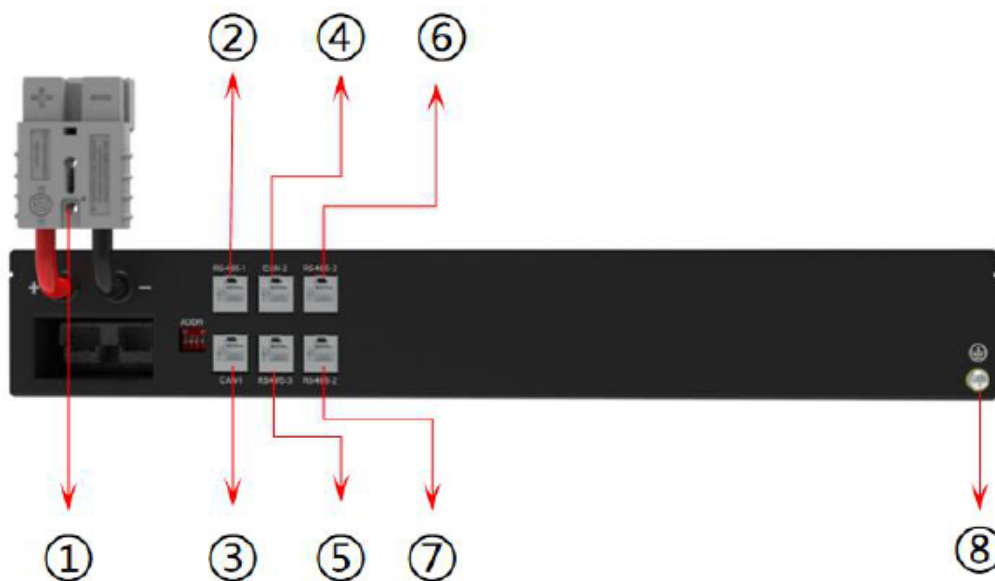

①: Positive and negative connector \* 2 - for battery parallel connection and power output, model: Anderson 120A

②: RS485-1 support the BMS monitor or customer's EMS device.

③: CAN-1 support Turbo, Goodwe, Solis, Sermatec, Sofar, Ingeteam Inverter.

④: CAN-2 support Victron inverter.

⑤: RS485-3 support Growatt inverter.

⑥: RS485-2 support Voltronic inverter and inner parallel communication between batteries.

⑦: RS485-2 support Voltronic inverter and inner parallel communication between batteries.

⑧ Handles

The standard packing list of Lithium Series Slim is as follows:

Item	Part Name	Description	Unit	Quantity
1	Battery	Lithium Series Slim	pcs	1
2	User Manual	Lithium Series Slim User Manual	pcs	1
3	RJ45 netting cable	RS485 parallel netting cable/0.2m	pcs	1
4		CANBUS communication cable with turbo inverter /2m	pcs	1
5		CANBUS communication cable with Victron inverter /2m	pcs	1
6		RS485 communication cable with Voltronic inverter /2m	pcs	1
7	Grounding wire	Black/1.5m/10AWG	pcs	1

### 5.3. Assembly and connection

Batteries may be connected in parallel up to a maximum of 15. All batteries must be grounded. It is suggested to connect the installation ground to the rack at the same point as all battery lands.

- **Connection between batteries:**
  - Up to 15 batteries are allowed to be used in parallel.
  - The batteries used in parallel must be the same batch of cases with the same SOC.
  - The Voltage difference of batteries used in parallel must be within 0,5V.
  - The dimensions of parallel cable must be the same.
  - The batteries must be connected two by two with the same cable to the bus, following next scheme.

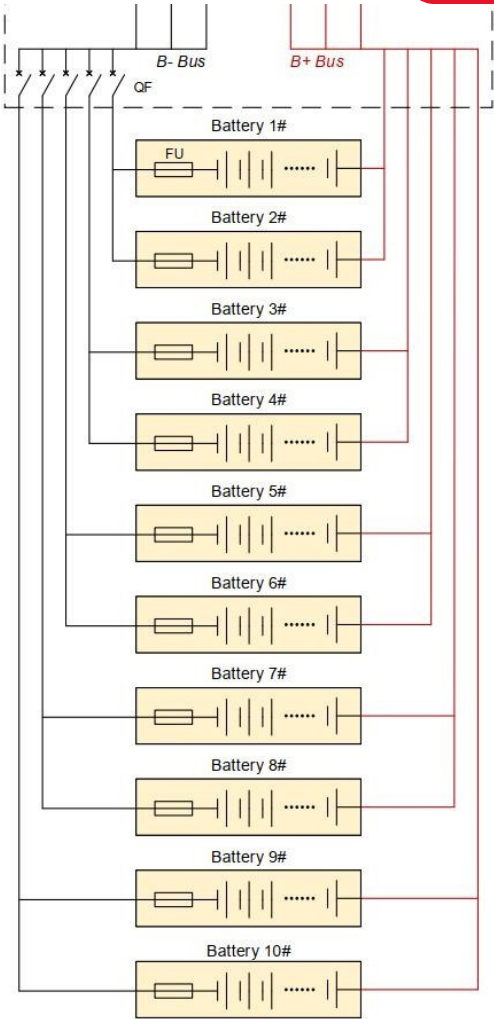

- **Connection between battery and inverter:**

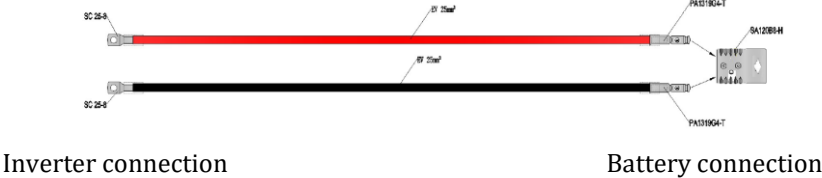

25 mm<sup>2</sup> power cable section.

**NOTE:** Each power cord can carry a maximum of 120 A, so every two batteries would need to connect a new cable to the inverter. However, if the inverter is 5 kW only with one cable it would be enough to be at the limit of the maximum current recommended.

**Warning when doing a battery expansion:** It is very important that in the case of connecting batteries in parallel that are not new (for example, we add a new battery to an existing system), we previously perform a voltage balancing (without load) between them to avoid overcurrents that could damage the system. As an alternative to balancing voltages, balancing can be done by equalizing the SOC of the batteries. In addition, when connecting new batteries, we must take into account that the number of batteries at the time of connection must be similar to the number of batteries that are already connected in the system. For example, if we have five batteries installed and we want to connect a new one, we must first connect the new battery with two of the five that were already in place to balance them, and then connect these three with the other three remaining batteries in the system. Batteries should always be connected in groups of similar numbers so that a large group cannot damage a smaller group of batteries at the time of connection.



There must be installed a higher power of batteries than the inverter power

The sum of batteries power must be higher than the sum of the inverters power

### 5.3.1. Configuration without communications

For those cases where the battery is intended to operate connected to an inverter without communications, it's not necessary to select a specific configuration of the DIP switches and the batteries do not need to be connected each other with the communication cable.

### 5.3.2. Configuration with communications

**Communication cable:** It will be configured one way or another depending on the inverter used.

#### Cable configuration Hybrid Inverter Turbo Energy/ Goodwe/Solis/Growatt

- It can be used a Straight-through cable
- Connect the cable to the CAN-2 port
- Growatt inverter is connected to the RS485-3 port

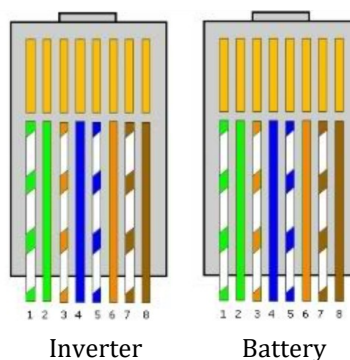



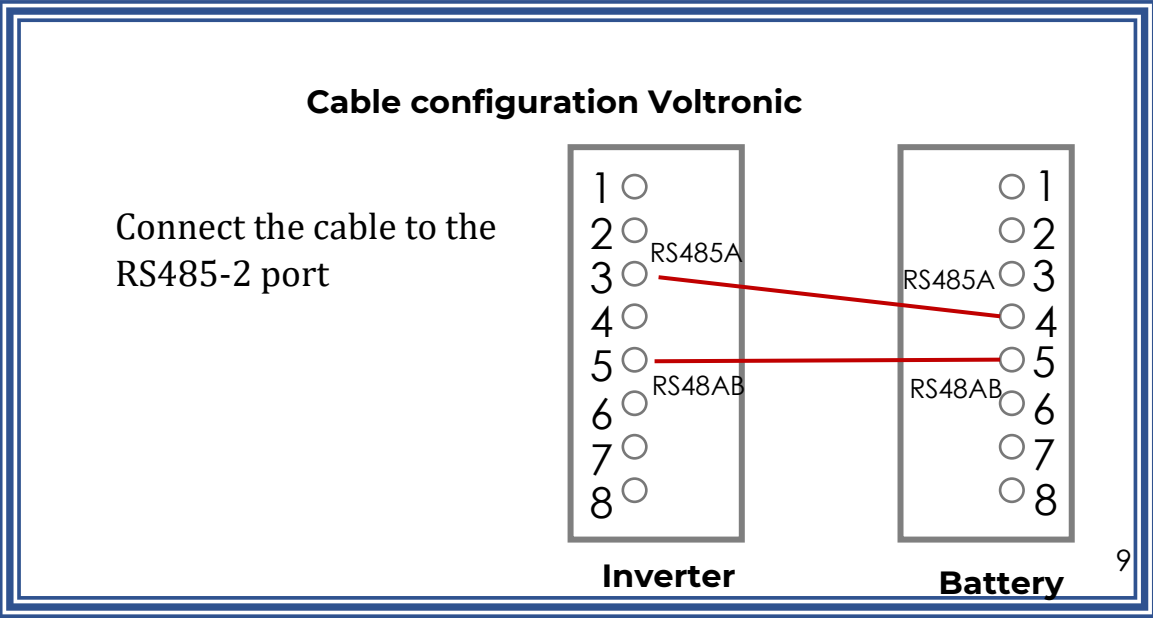
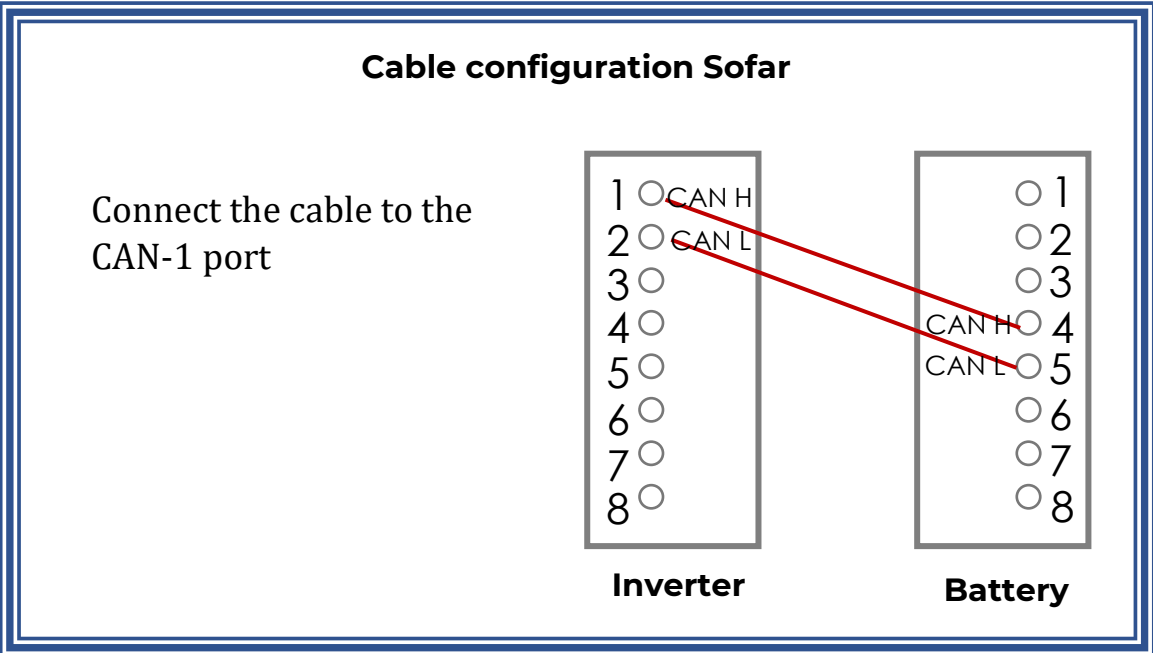
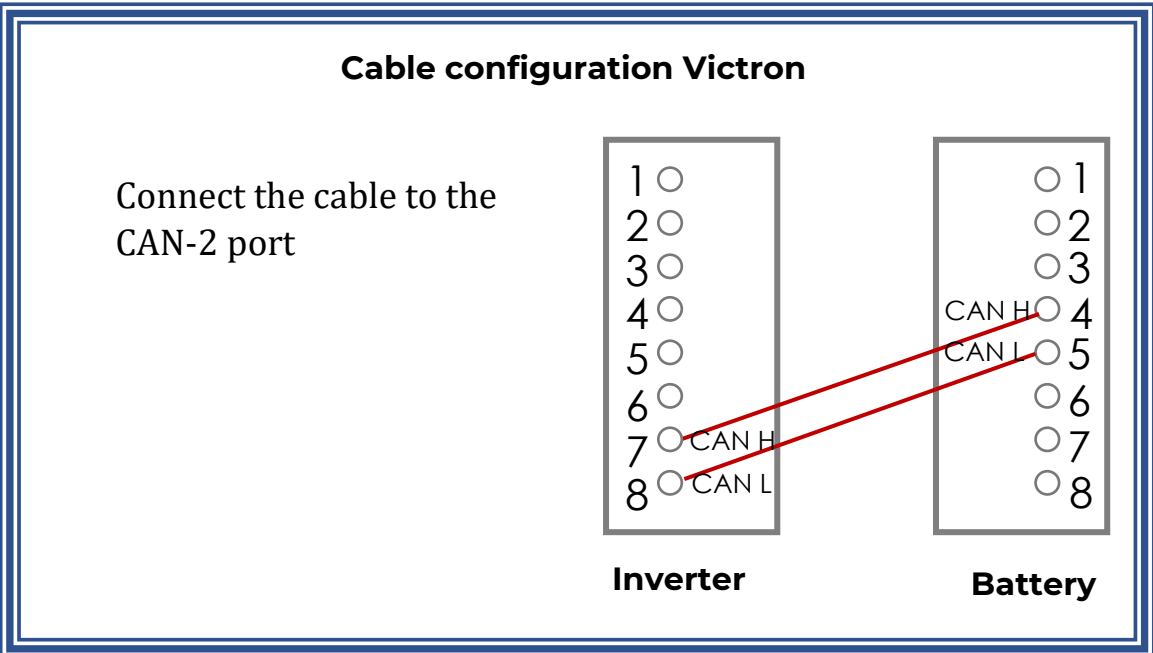

## DIP switch

Each module has 4 DIP switches (Dual Inline Package) that will be configured differently according to the number of batteries will be connected

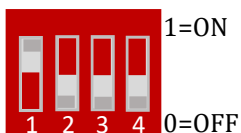

Address	Dial switch position				Explain
	#1	#2	#3	#4	
1	ON	OFF	OFF	OFF	Pack1/Master
2	OFF	ON	OFF	OFF	Pack2
3	ON	ON	OFF	OFF	Pack3
4	OFF	OFF	ON	OFF	Pack4
5	ON	OFF	ON	OFF	Pack5
6	OFF	ON	ON	OFF	Pack6
7	ON	ON	ON	OFF	Pack7
8	OFF	OFF	OFF	ON	Pack8
9	ON	OFF	OFF	ON	Pack9
10	OFF	ON	OFF	ON	Pack10
11	ON	ON	OFF	ON	Pack11
12	OFF	OFF	ON	ON	Pack12
13	ON	OFF	ON	ON	Pack13
14	OFF	ON	ON	ON	Pack14
15	ON	ON	ON	ON	Pack15

## 5.4. On and Off

For the connection between batteries, we need to follow the next connection procedure:

1. With all devices disconnected, we proceed to the connection of the batteries, cables between each other.
2. We connect the master battery to the inverter, both energy cable and communication cable.
3. We turn on the batteries.
4. We turn on the inverter.

To turn on the batteries, we must do it one by one. To turn them off, when turning off one, all of them will turn off at the same time.

To turn on, press the power button for 2 seconds. The BMS will start and the LCD screen light up.

To turn off the batteries, press the power button for more than 3-6 seconds.

### Sleep Function

When RS485/CAN communication interruption, no charge and discharge, no button operation, 5 minutes later, the system will go into sleep mode to reduce self-consumption. In this mode, the battery power connectors still have normal battery voltage.

When the battery is in the sleep mode and meets any of following conditions, the system will quit sleep mode and wake up.

1. Charge or discharge current is detected.
2. Press the “power” button for 1 second.
3. Access communication cable (RS485/CAN).

### Power down function

When any of the following conditions are satisfied, the system will go into power down mode to reduce self-consumption and protect the cells:

1. Press the “power” button for 3~6 seconds and release it;
2. The lowest cell voltage is lower than the power down voltage, and the duration reaches the power down delay time (while no charging current).







In this mode, the battery power connectors don't have voltage.

When the battery is in the power down mode and meets any of following conditions, the battery will quit power down mode and wake up.

- Charging current is detected (charging voltage should be higher than 48 V);
- Press the “power” button for 2 seconds and release it.

## 5.5. LED display

The LED light on the front of the battery will indicate the State Of Charge (SOC) as shown in the following table:

SOC LED	Estado de carga
	SOC < 5%
	5% ≤ SOC ≤ 25%
	25% ≤ SOC ≤ 50%
	50% ≤ SOC ≤ 75%
	75% ≤ SOC ≤ 95%
	SOC ≥ 95%







## 5.6. Protection codes

### LED Alarm

Red light: 1 flicker

Green light:

N.º flickers = protection code

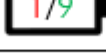







Protection Code	Display LED	Description
1		Temperature difference
3		High temperature
4		Low discharge temperature
5		Charge over-current
6		Discharge over-current
8		Cell overvoltage *
9		Cell under voltage
11		Low charge temperature

\* This error only operates in case that not all leds are illuminated. If all leds are on, means 100% charge. If not all, means cell overvoltage

### LED Alarm

Red light: 2 flickers

Green light: N.º flickers = error code

Error Code	Display LED	Description	Solution
Error 01		Hardware Error	Wait for automated recovery. If the problem is not resolved, call for repair.
Error 03		Hardware Error	
Error 05		Hardware Error	
Error 06		Open breaker	Close the circuit breaker after turning off the battery system.
Error 07		DIP difference	Maintain consistency of DIP switches, reboot system.
Error 08		LMU disconnected (slave)	Reconnect the communication cable.
Error 09		SN missing	Enter the serial number, restart the system or call for repair.
Error 10		LMU disconnected (master)	Reconnect the communication cable.
Error 11		Software version inconsistent	Call for repair.

If the battery constantly runs for 30 days and its **SOC has not been corrected**, the discharge function will not be available until the battery is fully charged at least once and the SOC is corrected.

If we find that the battery charges and discharges but the SOC doesn't, it might be a signal that the battery needs to be updated.

## 6. Appendix

### 6.1. Security instructions

1. Please read the battery instructions before use.
2. Keep the battery away from high voltage and out of reach of children.
3. In operation, the battery should be kept in the set temperature ranges (between -10°C and 50°C) and a humidity less than 80%.
4. During handling, be very careful to avoid bumps/falls of the battery.
5. Be careful not to touch the contacts at the same time.
6. The battery, at the end of its useful life, requires a recovery process, not disassemble it.
7. Avoid locating batteries in damp places to avoid danger.

8. When not in use for a long time, store the battery intact and let the battery be half charged. Wrap the battery with non-conductive material to avoid direct contact of the metal. Store the battery in a cool, dry place.
9. Never expose the battery to fire or water.

## 6.2. Safety warnings

1. Do not disassemble the batteries. The inside of the battery has a protective mechanism and a protective circuit to avoid danger. Improper disassembly will damage the protection function permanently, leaving the battery without safety conditions.
2. Never short-circuit the poles of the Battery. Avoid contact of positive and negative poles with metals.
3. Keep the batteries away from fire and extreme temperatures. Monitor the distance to thermal bulbs, stoves, etc.
4. Keep the battery away from the water. Always be careful that the battery is not located in damp places where the dew point can be reached.
5. Do not use batteries that have physical damage that may be due to falls or bumps.
6. Do not weld near the battery.
7. Overheating will result in the loss of the protective function of its life cycle, even, it could render the battery useless and in extreme cases self-ignition of the battery occurs.
8. Never connect this battery in series and connect it in parallel only with identical batteries up to a maximum number of 6.
9. If the battery has liquid leakage, avoid contact with it completely. It can be harmful to the skin, and if you touch the eyes, wash, and go to the hospital immediately for treatment.

## Warranty

Please refer to the **Warranty Document** for specific warranty terms.

## Shipping

During transportation, keep the battery from acutely vibration, impacting, solarization, drenching.

## Storage

Storage environment requirement :

1 month: Under temperature of -20°C~ 45°C and relative humidity of 45~85%. 3 months: Under temperature of -20°C~ 35°C and relative humidity of 45~85%.

6 months and more: Under temperature of -20°C~ 25°C and relative humidity of 45~85%.

The battery must be charged every six months, and must be charged and discharged a complete cycle every nine months.

## 6.3. Contact details

For any incident with the battery write, indicating your contact details, an email to the address: [info@turbo-e.com](mailto:info@turbo-e.com) and we will contact you as soon as possible.